

GILGEN SLX-M SLIDING DOOR DRIVE UNIT, COMBINED WITH PSF PROFILE SYSTEM

The ideal combination for elegant, full-glass configurations

The Gilgen SLX-M sliding door drive unit is a universally applicable drive system with state-of-the-art functions. It is designed to offer guaranteed, reliable functioning in a wide range of highly-demanding applications. The elegantly designed sensor system is built into the header profile.

Versatile usage

- Elegant, all-glazed appearance
- Fully-transparent
- Innovative fixing system (no drilling required for ESG-glass configurations)
- TÜV-approved, and conforms to the relevant norms and standards (such as EN 16005, DIN 18650)

Possible applications

- Single and bi-parting sliding doors
- Emergency-exit function (redundant configuration)
- Suitable for indoor applications, such as office partitions, multi retail outlets and smoking areas etc,
- For design orientated architectural solutions
- Standard locking system built into drive mechanism
- Fixed point guide
- A floor lock and a flush stainless steel bottom guide rail of slimline design can be used in combination with a horizontal bottom rail

- Can be attached to the door lintel or wall
- With side panel
- Translucent door-leaf seals

Glazing and infill options

- Safety glass ESG 10 / 12 mm
- Safety glass VSG-TVG 10 / 12 mm

Surface finish of aluminium profiles

- Anodised (coloured or colourless)
- RAL colours, Polyester powder coating (PPC)



The Gilgen SLX-M drive unit with matching PSF profile system - the elegant, full-glass solution for indoor applications such as shop-in-shop outlets



Gilgen SLX-M sliding door drive unit, combined with the PSF profile system

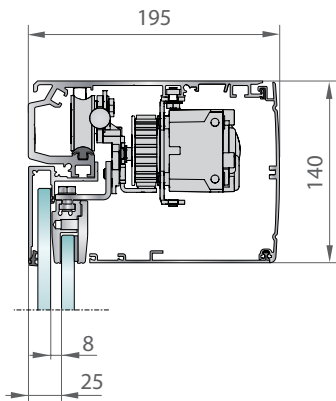

Single and bi-parting systems with side panel

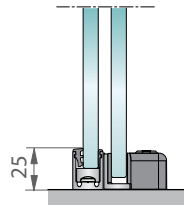

Fixed point guide

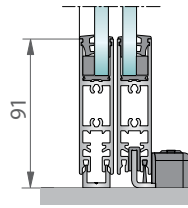

Fixed point guide with plinth profile

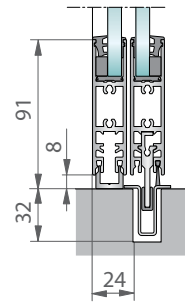

Continuous bottom guide rail with plinth profile

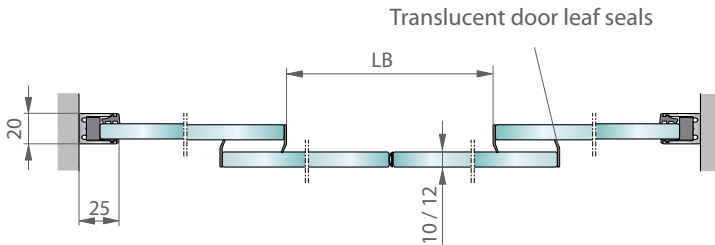

Bi-parting door with side panel
Wall mounting

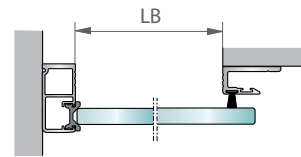

Single door leaf without side panel
Wall mounting

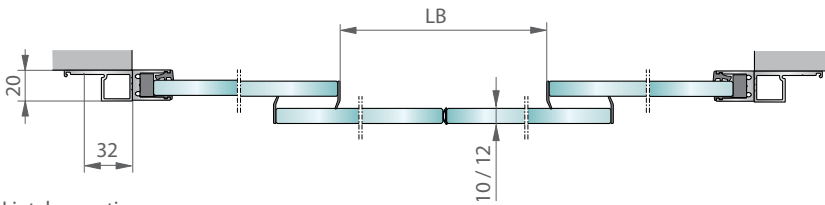

Lintel mounting

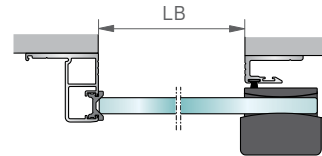

Lintel mounting

Range of application for Gilgen SLX-M sliding door drive unit with PSF profile system

		Bi-parting	Single door leaf
Sliding door SLX-M	Clear opening width	800 - 2500 mm	700 - 1500 mm
	Max. door leaf weight	2 x 120 kg	120 kg
	Max. clear height	standard 2100 mm / possible up to 2500 mm	
SLX-M redundant	Clear opening width	900 - 2500 mm	950 - 1500 mm
	Max. door leaf weight	2 x 120 kg	120 kg
	Max. clear height	2500 mm / with safety glass VSG max. 3000 mm	